

CUSTOMER WIRING INSTRUCTIONS TO SUIT :
UNIVERSAL GEN 111 & Manual Trans

Lay the C.A.E Engine loom in vehicle and plug in all the sensors. (The sensor plugs can only be connected one way). Mount the Castle Auto Electrical Control Loom with the relays and circuit breakers to Drivers side inner guard or sub frame. Making sure that the earth lug at the Circuit Breakers, with 3 black wires is secured under the mounting bolt.

Using terminals and plugs supplied, adapt original harness to the new loom as per colour codes and numbers on the 6 & 4 pin female plugs that are listed below:

A) 6 Pin Female plug

- 1. Red 6mm - Main cab feed (positive 50 amp Protection).
- 2. Pink - Ignition supply, with key in the on position.
- 3. Green - Water temp gauge.
- 4. Brown - Alternator light.
- 5. Blue - Oil light / gauge.
- 6. Violet - Starter motor signal.

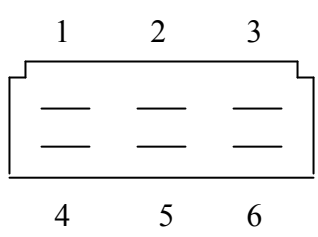

View all Plugs from the front
 i.e. wires come In from the rear

1) Battery Supply – 6mm Red

This is an auxiliary battery supply, (rated at 50 amps). It can be used for a number of things including power supply to the ignition switch.

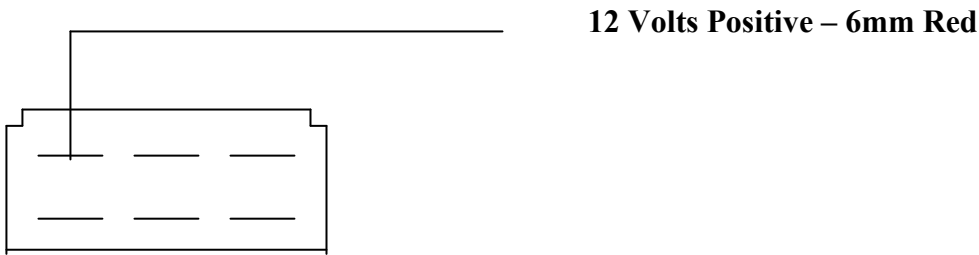

2) Ignition Supply - 3mm Pink

This is to be wired up to the Ignition switch. Making sure that there is 12 volts power when the key is in the ON position, and while the engine is being cranked.

IF VEHICLE WAS ORIGINALLY FITTED WITH POINTS:

You will have to find the ignition bypass wire and discard it. (Refer to **NOTE 3** on the last page of these notes).

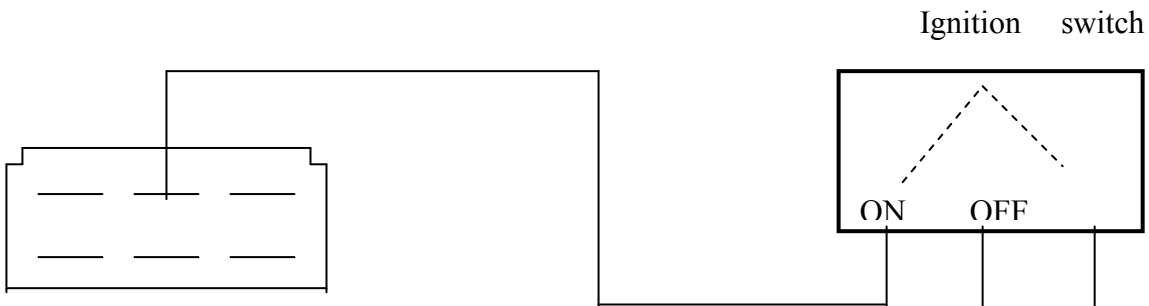

3) Temperature Gauge – 2mm Green

This is to be wired up to the Temperature gauge, if you are using the original temp gauge on the vehicle, you will have to change the temp sender to match.

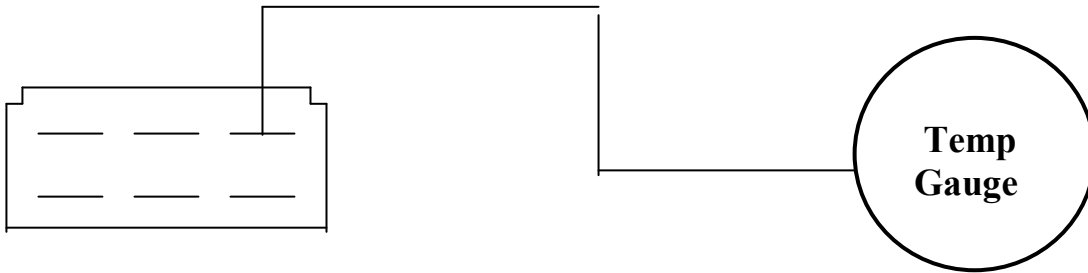

4) Alternator Lamp – 2mm Brown

This is to be wired to alternator warning light.

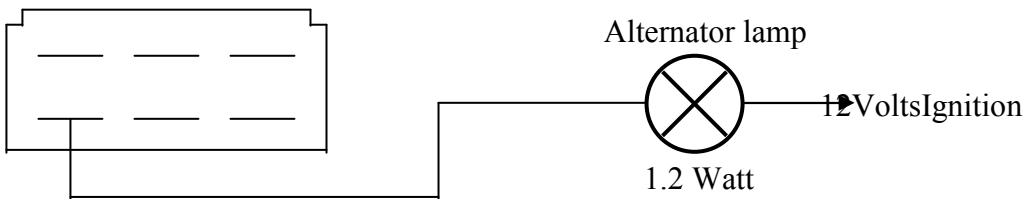

5) Oil Lamp / Gauge – 2mm Blue

This is to be wired to Oil warning light or oil gauge (Not both).

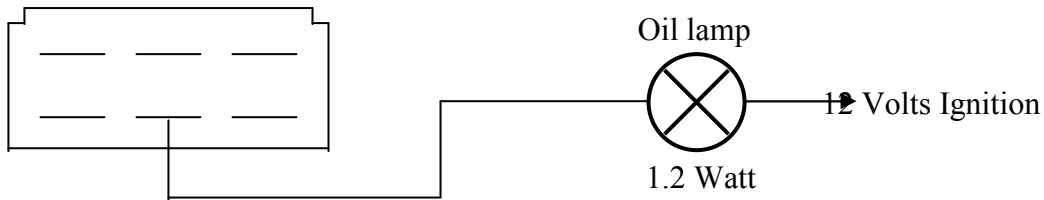

6) Starter motor Signal – 2mm Violet

This is to be wired to the start position on the ignition switch. If using an Automatic gearbox, wire this up through the inhibitor switch first.

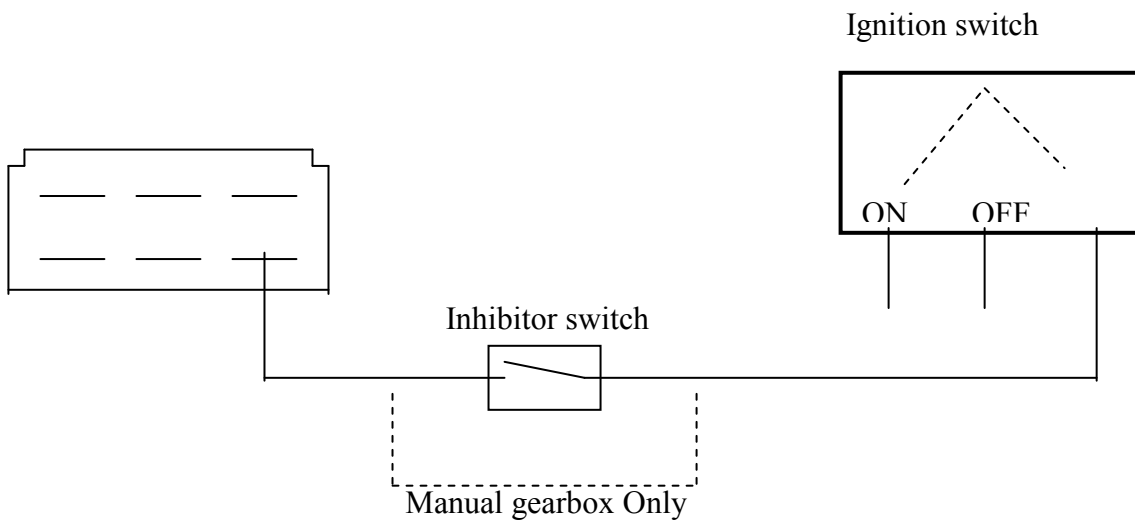

B) 4 Pin female plug

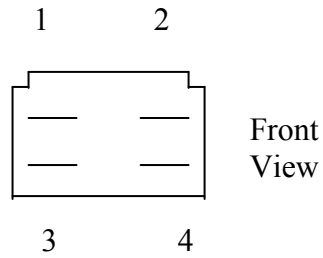

- | | |
|-----------|------------------------|
| 1) Brown | - Tacho Signal. |
| 2) Green | - A / C Switch. |
| 3) Grey | - Reverse Lights. |
| 4) White | - Speed sensor output. |

1) Tacho Signal – 2mm Brown

This is to wired up to the tacho signal, on the back of the tacho.



If using a Tacho on a V6, you need to purchase an Interface Box.

2) A / C Switch - 3mm Green

This is to be wired up to the A / C switch, through the blower fan. High & low pressure switches, and the E.V.A.P temp switch.

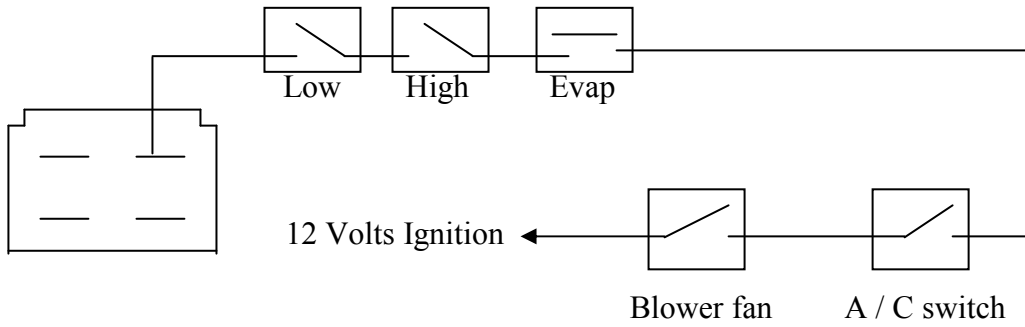

3) Reverse Lights – 3mm Grey

This is to be wired up to the Reverse lamps,

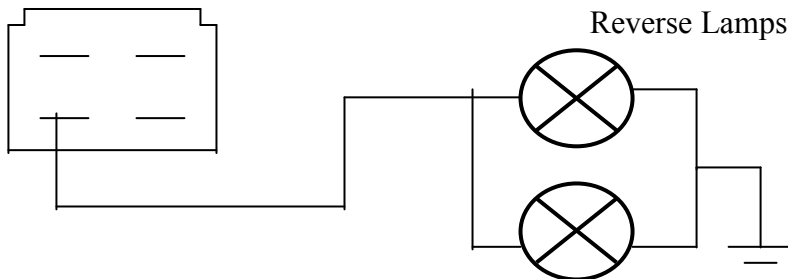

4) Speedo Signal output – 2mm White

This is to wired up to the Speedo output signal, on the back of the Speedo.
(Only use if running an electronic speedo in the dash).



(C) SPECIAL NOTES

(D) Run the fuel pump wiring down to the fuel pump and connect as follows :
(Red is positive - Black is negative)

(E) Run the thermo fan wiring down to the front of the radiator and with the 2 pin plug, wire in the fans.
Check the direction of the cooling fans. If the fan runs backwards, reverse the wires in the 2 pin plug (red & black)

(F) After final installation of the loom, check that all of the circuit breaker connection are tight.

Note 1: **Thermo Fan Circuit.**

Original Circuit for ;

Holden VT, VX, VU, VY Fans

Yellow = High Speed Earth Switching
Black = Low Speed Earth Switching
Green = Positive Feed from Fusible Link

Red = Positive Feed from Fusible Link

Ford Fans.

(1) Blue = High
(2) Blue = Low
(1) Black = Earth
(2) Black = Earth

Note 2: If Engine does not start.

- a) Do you have fuel pressure?
- b) Do you have Hi Tension Spark?
- c) Do you have Injection Pulse?
- d) Check Pin 2 on Control loom Ignition feed with test light and with the Ignition switched on and with the Engine cranking over the test light should stay on at all times.
If light fails to glow, go back to Note 1 and recheck ignition bypass.(see note 3 below)

Note 3: Ignition wire – Yellow, and resistor wire – White, these will have to be cut and joined together at the ignition switch terminals 1 & 2. To do this cut the white, and loop across into the pink wire, and crimp together. The White Resistor wire, can then be removed and discarded from loom.

Due to shortage of wire colours at times, there may be some wire colours that don't match. If this is the case follow the plug configuration.

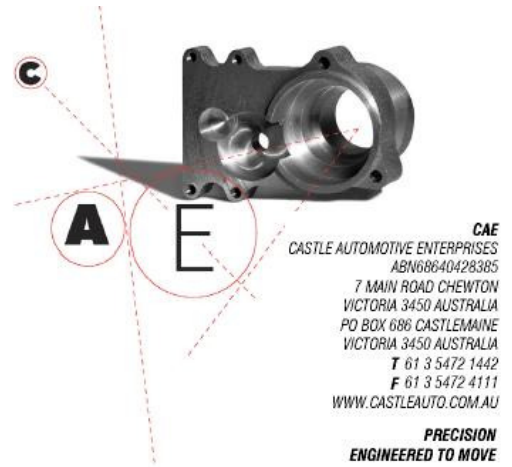

C.A.E. PERFORMANCE PRODUCTS PTY LTD LOOM WARRANTY

Manufacturer's Warranty:-

All Looms manufactured or modified by C.A.E. Performance Products Pty Ltd will be guaranteed against faulty workmanship for a period of twelve months.

The warranty is subject to the following conditions:-

- All claims must be made within the warranty period.
- Any loom manufactured or modified that has been found to have faulty workmanship or related faults due to the workmanship of C.A.E. Performance Products will be replaced or repaired free of charge.
- C.A.E Performance Products recommend that this product be fitted by qualified personnel.
- The warranty will not apply to a loom that has been installed incorrectly or has been subject to neglect, intentional or accidental damage, unauthorized repairs or modifications or used for the wrong application.
- The warranty does not cover installation or removal of wiring loom or freight costs.
- The warranty will only apply to wiring looms used for normal road use.

